

TPS22998 5.5V、10A、导通电阻为 4mΩ 的负载开关

1 特性

- 输入电压范围 (V_{IN}) : 0.2 V 至 5.5V
- 偏置电压范围 : 2.2 V 至 5.5V
- 最大持续电流 : 10A
- 导通电阻 (R_{ON}) : 4mΩ (典型值)
- 带三态引脚的可调压摆率
- 快速输出放电 (QOD) : 50 Ω
- 热关断
- 低功耗 :
 - 导通状态 (I_Q) : 15 μA (典型值)
 - 关闭状态 (I_{SD}) : 3 μA (典型值)

2 应用

- 固态硬盘
- PC 和笔记本电脑
- 工业 PC
- 光学模块

3 说明

TPS22998 是一款单通道负载开关，具有可配置上升时间，从而可更大限度地降低浪涌电流。此器件包含一个可在 0.2V 至 5.5V 输入电压范围内运行的 N 沟道 MOSFET，并且支持 10A 的最大连续电流。

开关可由一个打开和关闭输入 (ON) 控制，此输入可与低压控制信号 ($V_{IH} = 0.9V$) 直接连接。TPS22998 在开关关闭时具有固定快速输出放电，将输出下拉至接地。

TPS22998 采用 10 引脚 WQFN 封装 (RYZ) (1.5mm × 2mm，间距为 0.5mm) 并可在自然通风条件下的 -40°C 至 +105°C 温度范围运行。

器件信息

器件型号	封装 ⁽¹⁾	封装尺寸 (标称值)
TPS22998	WQFN (10)	1.5mm × 2.0mm

(1) 要了解所有可用封装，请参见产品说明书末尾的可订购产品附录。

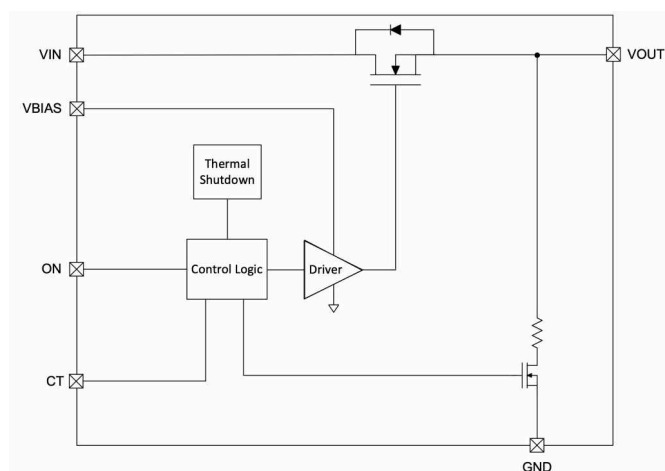

TPS22998 方框图

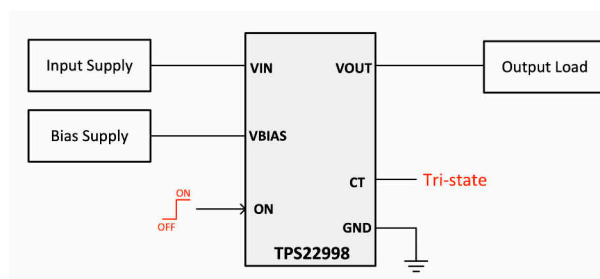

TPS22998 典型应用



Table of Contents

1 特性	1	7.2 Functional Block Diagram.....	11
2 应用	1	7.3 Feature Description.....	11
3 说明	1	7.4 Device Functional Modes.....	12
4 Revision History	2	8 Application and Implementation	13
5 Pin Configuration and Functions	3	8.1 Application Information.....	13
6 Specifications	4	8.2 Typical Application.....	13
6.1 Absolute Maximum Ratings.....	4	9 Power Supply Recommendations	15
6.2 ESD Ratings.....	4	10 Layout	15
6.3 Recommended Operating Conditions.....	4	10.1 Layout Guidelines.....	15
6.4 Thermal Information.....	4	10.2 Layout Example.....	15
6.5 Electrical Characteristics (VBIAS = 5 V).....	5	11 Device and Documentation Support	16
6.6 Electrical Characteristics (VBIAS = 3.3 V).....	5	11.1 接收文档更新通知.....	16
6.7 Electrical Characteristics (VBIAS = 2.2 V).....	6	11.2 支持资源.....	16
6.8 Switching Characteristics (VBIAS = 2.2 V to 5 V).....	7	11.3 Trademarks.....	16
6.9 Timing Diagram.....	8	11.4 Electrostatic Discharge Caution.....	16
6.10 Typical Characteristics.....	9	11.5 术语表.....	16
7 Detailed Description	11	12 Mechanical, Packaging, and Orderable Information	17
7.1 Overview.....	11		

4 Revision History

注：以前版本的页码可能与当前版本的页码不同

Changes from Revision * (October 2021) to Revision A (December 2021)	Page
• 将数据表状态从“预告信息”更改为“量产数据”	1

5 Pin Configuration and Functions



图 5-1. TPS22998 RYZ Package, 10-Pin WQFN (Top View)

表 5-1. Pin Functions

PIN		I/O ⁽¹⁾	DESCRIPTION
NAME	NO.		
VBIAS	1	I	Device bias supply
VIN	2, 3, 4	I	Switch input
GND	5	G	Device ground
VOUT	6, 7, 8	O	Switch output
CT	9	I	Slew rate control - can be pulled up, left floating, or tie to ground
ON	10	I	Enable pin

(1) I = Input, O = Output, I/O = Input or Output, G = Ground, P = Power.

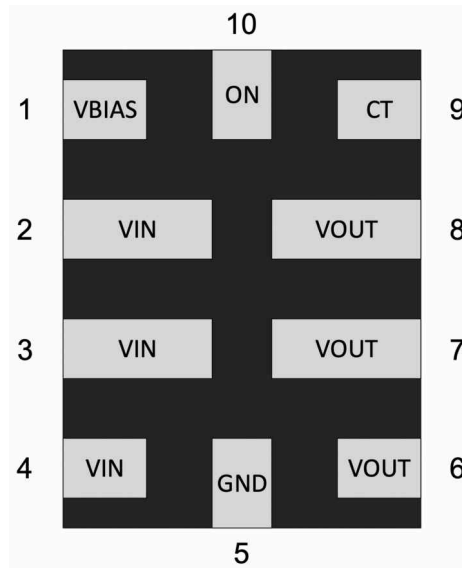
6 Specifications

6.1 Absolute Maximum Ratings

over operating free-air temperature range (unless otherwise noted)⁽¹⁾

		MIN	MAX	UNIT
V _{IN}	Input Voltage	- 0.3	6	V
V _{BIAS}	Bias Voltage	- 0.3	6	V
V _{ON, VCT}	Control Pin Voltage	- 0.3	6	V
I _{MAX}	Maximum Current		10	A
T _J	Junction temperature		Internally Limited	°C
T _{stg}	Storage temperature	- 65	150	°C

- (1) Operation outside the Absolute Maximum Ratings may cause permanent device damage. Absolute Maximum Ratings do not imply functional operation of the device at these or any other conditions beyond those listed under Recommended Operating Conditions. If used outside the Recommended Operating Conditions but within the Absolute Maximum Ratings, the device may not be fully functional, and this may affect device reliability, functionality, performance, and shorten the device lifetime.

6.2 ESD Ratings

			VALUE	UNIT
V _(ESD)	Electrostatic discharge	Human body model (HBM), per ANSI/ESDA/ JEDEC JS-001 ⁽¹⁾	±2000	V
		Charged device model (CDM), per ANSI/ESDA/ JEDEC JS-002 ⁽²⁾	±1000	

- (1) JEDEC document JEP155 states that 500-V HBM allows safe manufacturing with a standard ESD control process.
 (2) JEDEC document JEP157 states that 250-V CDM allows safe manufacturing with a standard ESD control process.

6.3 Recommended Operating Conditions

over operating free-air temperature range (unless otherwise noted)

		MIN	NOM	MAX	UNIT
V _{IN}	Input Voltage	0.2		5.5	V
V _{BIAS}	Bias Voltage	2.2		5.5	V
V _{CT}	Control Pin Voltage	0		5.5	V
T _A	Ambient Temperature	- 40		105	°C

6.4 Thermal Information

THERMAL METRIC ⁽¹⁾		TPS22998	UNIT
		RYZ (WQFN)	
		10 PINS	
R _{θJA}	Junction-to-ambient thermal resistance	84.1	°C/W
R _{θJC(top)}	Junction-to-case (top) thermal resistance	77.5	°C/W
R _{θJB}	Junction-to-board thermal resistance	16.6	°C/W
Ψ _{JT}	Junction-to-top characterization parameter	4.0	°C/W
Υ _{JB}	Junction-to-board characterization parameter	16.0	°C/W

- (1) For more information about traditional and new thermal metrics, see the [Semiconductor and IC Package Thermal Metrics](#) application report.

6.5 Electrical Characteristics (VBIAS = 5 V)

Over operating free-air temperature range (unless otherwise noted). Typical values are at $T_A = 25^\circ\text{C}$.

PARAMETER		TEST CONDITIONS	T_A	MIN	TYP	MAX	UNIT
Power Consumption							
$I_{SD,VBIAS}$	VBIAS Shutdown Current	ON = 0 V	25°C	3			µA
			- 40°C to 85°C	5			µA
			- 40°C to 105°C	6			µA
$I_{Q,VBIAS}$	VBIAS Quiescent Current	ON > V_{IH}	25°C	15			µA
			- 40°C to 85°C	20			µA
			- 40°C to 105°C	20			µA
$I_{SD,VIN}$	VIN Shutdown Current	ON = 0 V	25°C	0.1			µA
			- 40°C to 85°C	1			µA
			- 40°C to 105°C	2			µA
I_{ON}	ON pin leakage	ON = VBIAS	- 40°C to 105°C	0.1			µA
Performance							
R_{ON}	On-Resistance	VIN = 0.2 V to 5 V	25°C	4			mΩ
			- 40°C to 85°C	6			mΩ
			- 40°C to 105°C	7			mΩ
V_{IH}	Turn on threshold, rising		- 40°C to 105°C	0.765	0.9	1.035	V
V_{IL}	Turn off threshold, falling		- 40°C to 105°C	0.595	0.7	0.805	V
$V_{ON,HYST}$	ON pin hysteresis		- 40°C to 105°C	0.2			V
$t_{ON,DEGLITCH}$	On pin deglitch time		- 40°C to 105°C	2	5	7	µs
R_{QOD}	QOD Resistance	VOUT = VIN	25°C	50			Ω
			- 40°C to 105°C	40	60		Ω
Protection							
TSD	Thermal Shutdown		-	130	150	180	°C
TSD _{HYS}	Thermal Shutdown Hysteresis		-	20			°C

6.6 Electrical Characteristics (VBIAS = 3.3 V)

Over operating free-air temperature range (unless otherwise noted). Typical values are at $T_A = 25^\circ\text{C}$.

PARAMETER		TEST CONDITIONS	T_A	MIN	TYP	MAX	UNIT
Power Consumption							
$I_{SD,VBIAS}$	VBIAS Shutdown Current	ON = 0 V	25°C	3			µA
			- 40°C to 85°C	5			µA
			- 40°C to 105°C	5			µA
$I_{Q,VBIAS}$	VBIAS Quiescent Current	ON > V_{IH}	25°C	15			µA
			- 40°C to 85°C	20			µA
			- 40°C to 105°C	20			µA
$I_{SD,VIN}$	VIN Shutdown Current	ON = 0 V	25°C	0.1			µA
			- 40°C to 85°C	1			µA
			- 40°C to 105°C	3			µA
I_{ON}	ON pin leakage	ON = VBIAS	- 40°C to 105°C	0.1			µA
Performance							

6.6 Electrical Characteristics (VBIAS = 3.3 V) (continued)

Over operating free-air temperature range (unless otherwise noted). Typical values are at $T_A = 25^\circ\text{C}$.

PARAMETER		TEST CONDITIONS	T_A	MIN	TYP	MAX	UNIT
R_{ON}	On-Resistance	$V_{IN} = 0.2\text{ V to }3.3\text{ V}$	25°C	4			$\text{m}\Omega$
			$-40^\circ\text{C to }85^\circ\text{C}$	7			$\text{m}\Omega$
			$-40^\circ\text{C to }105^\circ\text{C}$	7			$\text{m}\Omega$
V_{IH}	ON pin turn on threshold, rising		$-40^\circ\text{C to }105^\circ\text{C}$	0.765	0.9	1.035	V
V_{IL}	ON pin turn off threshold, falling		$-40^\circ\text{C to }105^\circ\text{C}$	0.595	0.7	0.805	V
$V_{ON, HYST}$	ON pin hysteresis		$-40^\circ\text{C to }105^\circ\text{C}$	0.2			V
$t_{ON, DEGLITCH}$	On pin deglitch time		$-40^\circ\text{C to }105^\circ\text{C}$	2	5	6.5	μs
R_{QOD}	QOD Resistance	$V_{OUT} = V_{IN}$	25°C	50			Ω
			$-40^\circ\text{C to }105^\circ\text{C}$	40	60		Ω
Protection							
TSD	Thermal Shutdown		-	130	150	180	$^\circ\text{C}$
TSD _{HYS}	Thermal Shutdown Hysteresis		-	20			$^\circ\text{C}$

6.7 Electrical Characteristics (VBIAS = 2.2 V)

Over operating free-air temperature range (unless otherwise noted). Typical values are at $T_A = 25^\circ\text{C}$.

PARAMETER		TEST CONDITIONS	T_A	MIN	TYP	MAX	UNIT
Power Consumption							
$I_{SD, VBIAS}$	VBIAS Shutdown Current	$ON = 0\text{ V}$	25°C	3			μA
			$-40^\circ\text{C to }85^\circ\text{C}$	5			μA
			$-40^\circ\text{C to }105^\circ\text{C}$	5			μA
$I_{Q, VBIAS}$	VBIAS Quiescent Current	$ON > V_{IH}$	25°C	15			μA
			$-40^\circ\text{C to }85^\circ\text{C}$	20			μA
			$-40^\circ\text{C to }105^\circ\text{C}$	20			μA
$I_{SD, VIN}$	VIN Shutdown Current	$ON = 0\text{ V}$	25°C	0.1			μA
			$-40^\circ\text{C to }85^\circ\text{C}$	1			μA
			$-40^\circ\text{C to }105^\circ\text{C}$	3			μA
I_{ON}	ON pin leakage	$ON = V_{BIAS}$	$-40^\circ\text{C to }105^\circ\text{C}$	0.1			μA
Performance							
R_{ON}	On-Resistance	$V_{IN} = 0.2\text{ V to }2.2\text{ V}$	25°C	4.3			$\text{m}\Omega$
			$-40^\circ\text{C to }85^\circ\text{C}$	7			$\text{m}\Omega$
			$-40^\circ\text{C to }105^\circ\text{C}$	7			$\text{m}\Omega$
V_{IH}	ON pin turn on threshold, rising		$-40^\circ\text{C to }105^\circ\text{C}$	0.765	0.9	1.035	V
V_{IL}	ON pin turn off threshold, falling		$-40^\circ\text{C to }105^\circ\text{C}$	0.595	0.7	0.805	V
$V_{ON, HYST}$	ON pin hysteresis		$-40^\circ\text{C to }105^\circ\text{C}$	0.2			V
$t_{ON, DEGLITCH}$	On pin deglitch time		$-40^\circ\text{C to }105^\circ\text{C}$	2	4.5	6.5	μs
R_{QOD}	QOD Resistance	$V_{OUT} = V_{IN}$	25°C	50			Ω
			$-40^\circ\text{C to }105^\circ\text{C}$	40	60		Ω
Protection							
TSD	Thermal Shutdown		-	130	150	180	$^\circ\text{C}$

Over operating free-air temperature range (unless otherwise noted). Typical values are at $T_A = 25^\circ\text{C}$.

PARAMETER		TEST CONDITIONS	T_A	MIN	TYP	MAX	UNIT
TSD _{HYS}	Thermal Shutdown Hysteresis		-		20		°C

6.8 Switching Characteristics (V_{BIAS} = 2.2 V to 5 V)

Over operating free-air temperature range (unless otherwise noted), C_{IN}=47uF. Typical values are at $T_A = 25^\circ\text{C}$, C_L = 0.1 μF, and a current load of 1mA.

PARAMETER		TEST CONDITIONS	MIN	TYP	MAX	UNIT
VIN = 5 V						
t _{ON}	Turn ON time	CT = Open		250		us
t _{ON}	Turn ON time	CT = V _{BIAS}		1870		us
t _{ON}	Turn ON time	CT = GND		3728		us
t _{RISE}	Rise time	CT = Open		225		us
t _{RISE}	Rise time	CT = V _{BIAS}		1838		us
t _{RISE}	Rise time	CT = GND		3697		us
t _D	Delay time	CT = Open		26		us
t _D	Delay time	CT = V _{BIAS}		31		us
t _D	Delay time	CT = GND		31		us
t _{FALL}	Fall time	CT = Open		11		us
t _{OFF}	Turn OFF time	CT = Open		3		us
VIN = 3.3 V						
t _{ON}	Turn ON time	CT = Open		175		us
t _{ON}	Turn ON time	CT = V _{BIAS}		1261		us
t _{ON}	Turn ON time	CT = GND		3586		us
t _{RISE}	Rise time	CT = Open		150		us
t _{RISE}	Rise time	CT = V _{BIAS}		1232		us
t _{RISE}	Rise time	CT = GND		2478		us
t _D	Delay time	CT = Open		26		us
t _D	Delay time	CT = V _{BIAS}		29		us
t _D	Delay time	CT = GND		29		us
t _{FALL}	Fall time	CT = Open		11		us
t _{OFF}	Turn OFF time	CT = Open		3		us
VIN = 1.8 V						
t _{ON}	Turn ON time	CT = Open		102		us
t _{ON}	Turn ON time	CT = V _{BIAS}		664		us
t _{ON}	Turn ON time	CT = GND		1302		us
t _{RISE}	Rise time	CT = Open		75		us
t _{RISE}	Rise time	CT = V _{BIAS}		634		us
t _{RISE}	Rise time	CT = GND		1272		us
t _D	Delay time	CT = Open		27		us
t _D	Delay time	CT = V _{BIAS}		29		us
t _D	Delay time	CT = GND		30		us
t _{FALL}	Fall time	CT = Open		11		us
t _{OFF}	Turn OFF time	CT = Open		3		us
VIN = 0.6 V						
t _{ON}	Turn ON time	CT = Open		51		us
t _{ON}	Turn ON time	CT = V _{BIAS}		213		us

6.8 Switching Characteristics (VBIAS = 2.2 V to 5 V) (continued)

Over operating free-air temperature range (unless otherwise noted), C_{IN}=47uF. Typical values are at T_A = 25°C, C_L = 0.1 μ F, and a current load of 1mA.

PARAMETER		TEST CONDITIONS	MIN	TYP	MAX	UNIT
t _{ON}	Turn ON time	CT = GND		393		us
t _{RISE}	Rise time	CT = Open		23		us
t _{RISE}	Rise time	CT = V _{BIAS}		183		us
t _{RISE}	Rise time	CT = GND		365		us
t _D	Delay time	CT = Open		27		us
t _D	Delay time	CT = V _{BIAS}		29		us
t _D	Delay time	CT = GND		29		us
t _{FALL}	Fall time	CT = Open		10		us
t _{OFF}	Turn OFF time	CT = Open		4		us
VIN = 0.285 V						
t _{ON}	Turn ON time	CT = Open		37		us
t _{ON}	Turn ON time	CT = V _{BIAS}		96		us
t _{ON}	Turn ON time	CT = GND		158		us
t _{RISE}	Rise time	CT = Open		11		us
t _{RISE}	Rise time	CT = V _{BIAS}		66		us
t _{RISE}	Rise time	CT = GND		128		us
t _D	Delay time	CT = Open		27		us
t _D	Delay time	CT = V _{BIAS}		29		us
t _D	Delay time	CT = GND		30		us
t _{FALL}	Fall time	CT = Open		9		us
t _{OFF}	Turn OFF time	CT = Open		4		us

6.9 Timing Diagram



图 6-1. TPS22998 Timing Diagram

6.10 Typical Characteristics



图 6-2. Quiescent Current vs Input Voltage

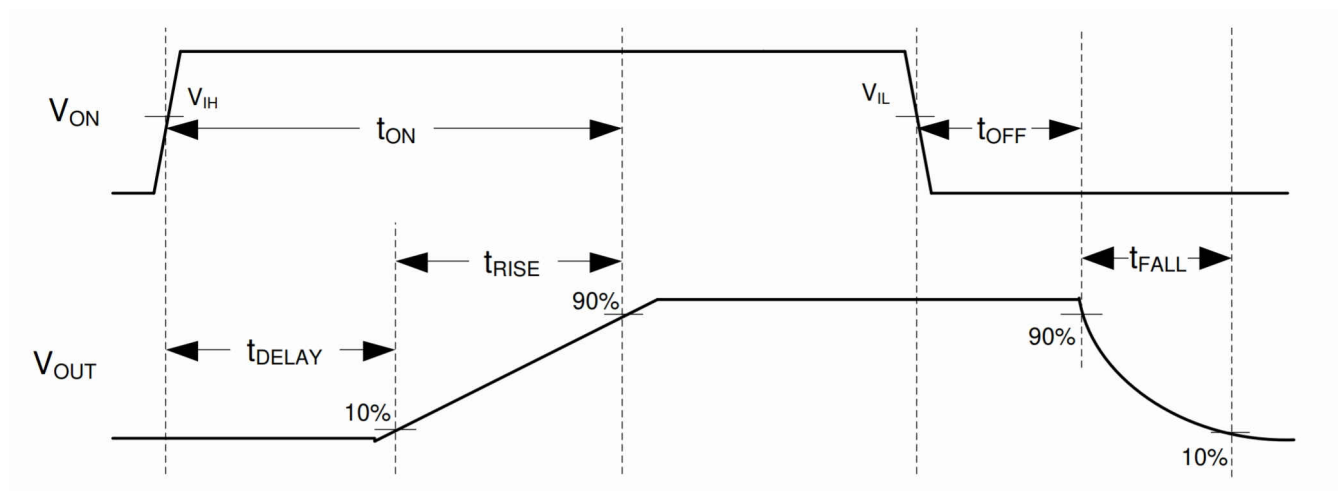

图 6-3. Quiescent Current vs Bias Voltage

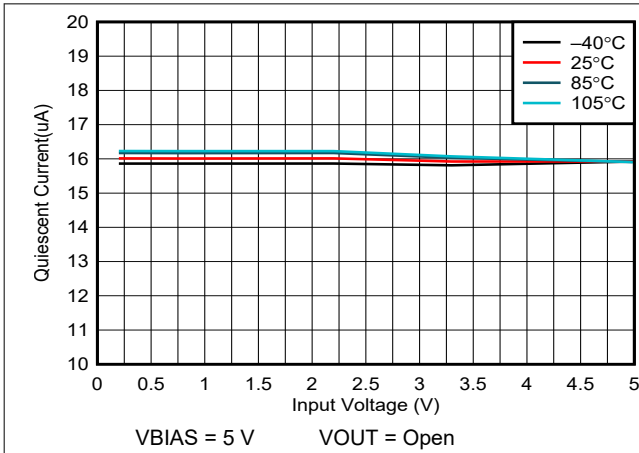

图 6-4. VBIAS Shutdown Current vs Input Voltage

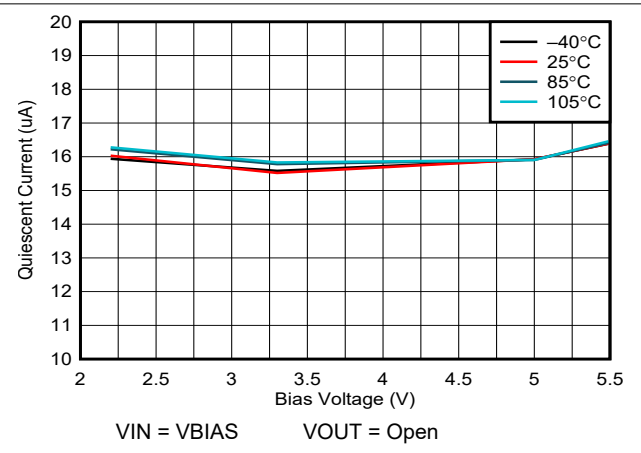

图 6-5. VBIAS Shutdown Current vs Bias Voltage

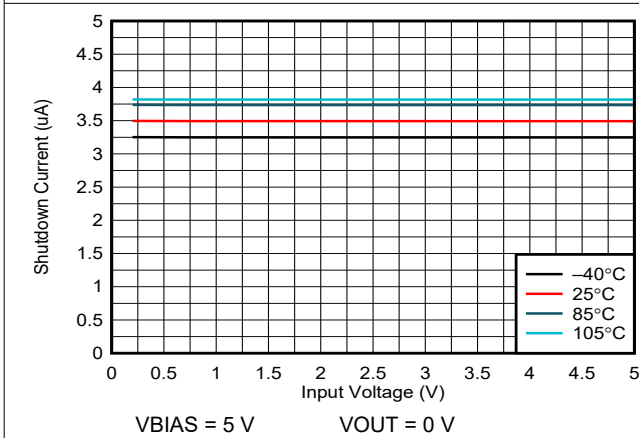

图 6-6. On-Resistance vs Input Voltage

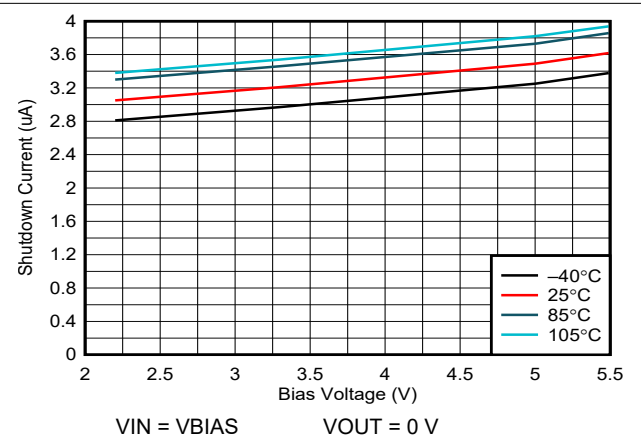

图 6-7. QOD Resistance vs Bias Voltage

6.10 Typical Characteristics (continued)

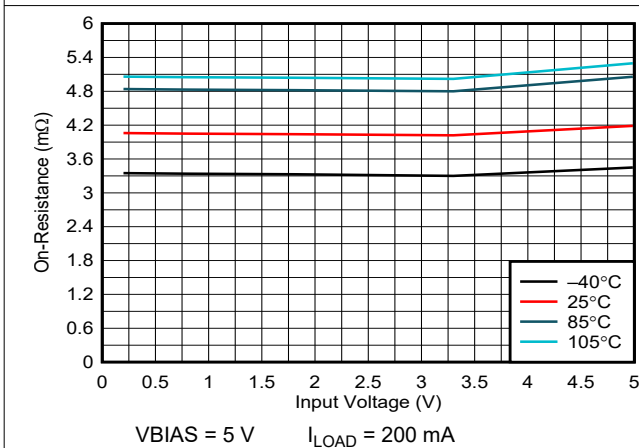

7 Detailed Description

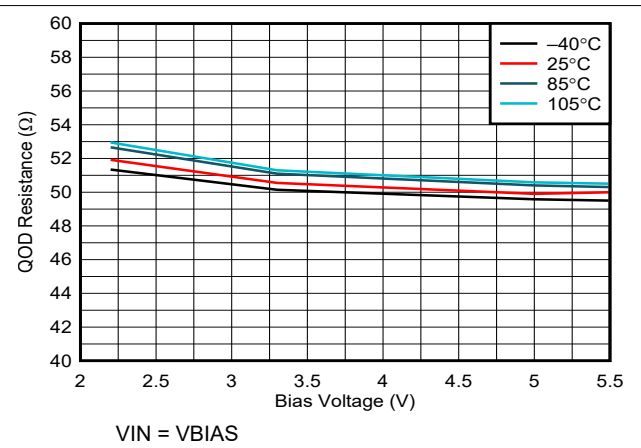
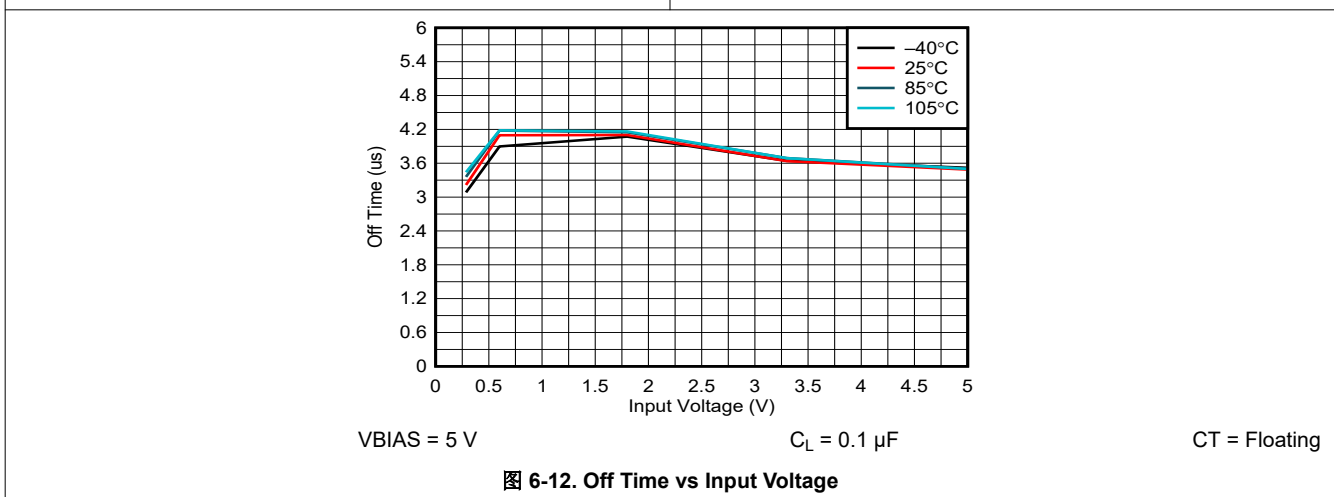
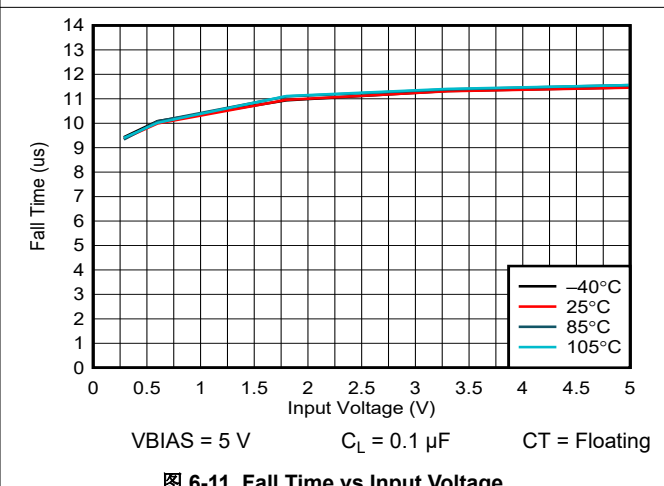
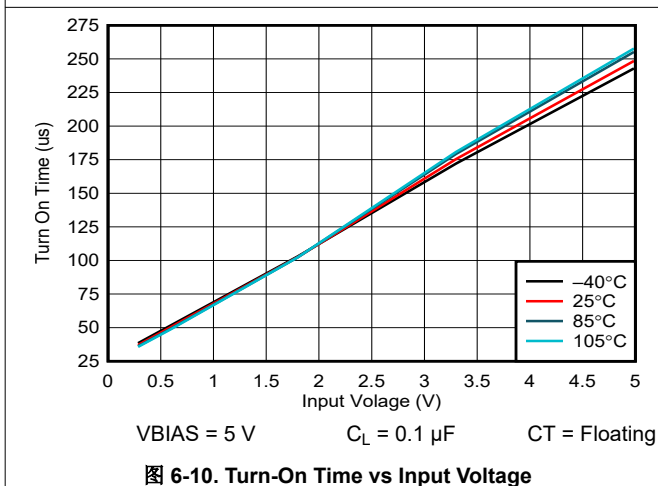
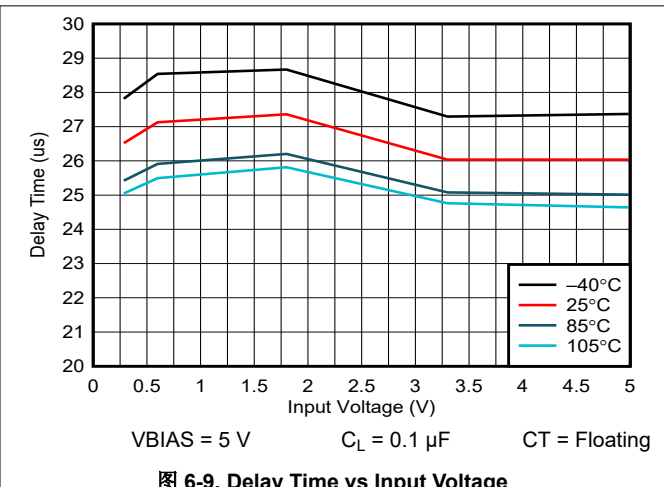
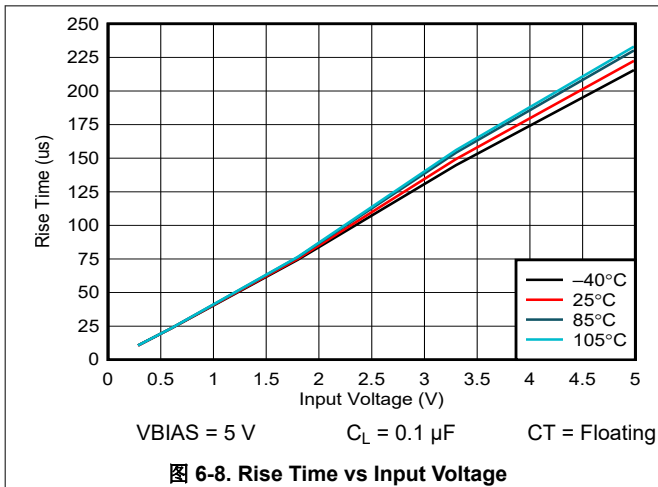
7.1 Overview

The TPS22998 device is a single-channel load switch with a 4-m Ω power MOSFET designed to operate up to 10 A. The voltage range is 0.2 V to 5.5 V. A configurable rise time provides flexibility for power sequencing and minimizes inrush current for high capacitance loads.

An enable pin (ON) controls the switch, which is capable of interfacing directly with low voltage GPIO signals. The TPS22998 device uses quick output discharge when switch turns off, pulling the output down to 0 V through an internal 50- Ω resistor.

7.2 Functional Block Diagram

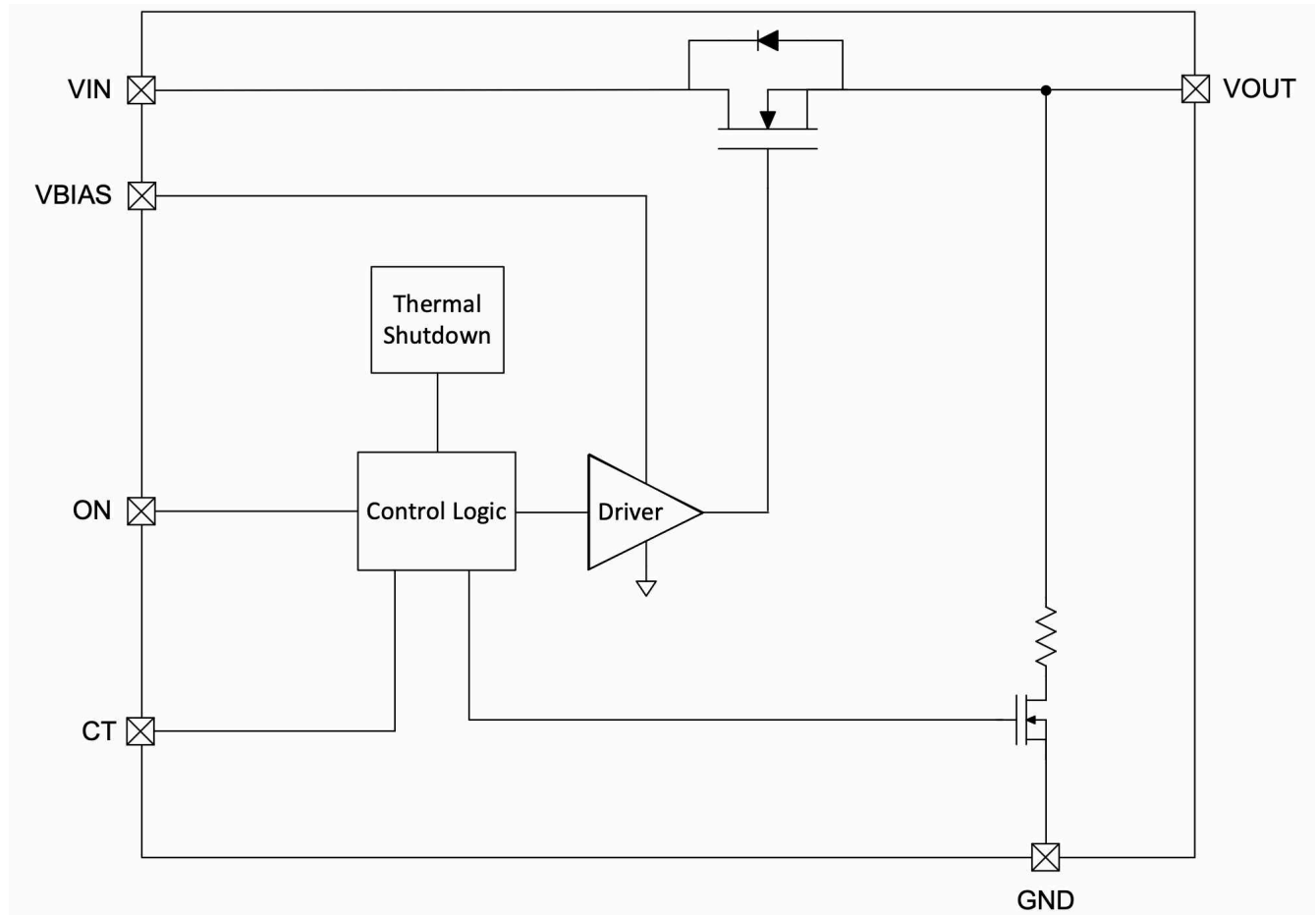

7.3 Feature Description

7.3.1 ON and OFF Control

The ON pin controls the state of the switch. The ON pin is compatible with standard GPIO logic threshold so it can be used in a wide variety of applications. When the pin pull high, the device enables, and when it is low, the device disables.

7.3.2 Adjustable Slew Rate

The CT pin is a tri-state pin, meaning that it has three different slew rates depending on the connection to the pin. The CT pin can be grounded, pulled high, or left floating. Floating defines as an effective resistance to GND or other pins greater than 10 M Ω .

7.3.3 Thermal Shutdown

When the device temperature reaches 150°C (typical), the device shuts itself off to prevent thermal damage. After it cools off by about 20°C, the device turns back on. If the device is kept in a thermally stressful environment, then the device oscillates between these two states until it can keep its temperature below the thermal shutdown point.

7.4 Device Functional Modes

The below table summarizes the device functional modes:

ON	Fault Condition	VOUT State
L	None	QOD to GND
H	None	Connected to VIN
H	Thermal shutdown	QOD to GND

8 Application and Implementation

备注

Information in the following applications sections is not part of the TI component specification, and TI does not warrant its accuracy or completeness. TI's customers are responsible for determining suitability of components for their purposes, as well as validating and testing their design implementation to confirm system functionality.

8.1 Application Information

This section highlights some of the design considerations when implementing this device in various applications.

8.2 Typical Application

This typical application demonstrates how to use the TPS22998 device to limit startup inrush current.



图 8-1. TPS22998 Basic Application

8.2.1 Design Requirements

For this example, the values below are used as the design parameters.

表 8-1. Design Parameters

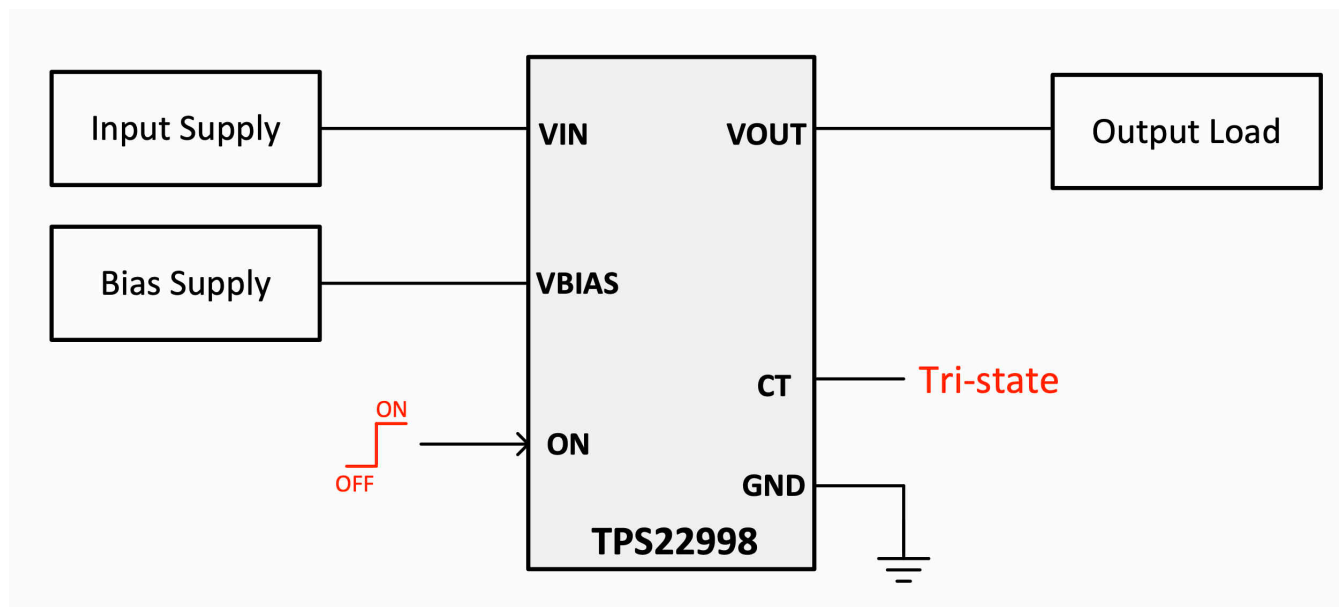
PARAMETER	VALUE
V_{BIAS}	3.3 V
V_{IN}	1.8 V
Load capacitance	470 μ F
Maximum inrush current	1 A

8.2.2 Detailed Design Procedure

When the switch enables, the charge up the output capacitance from 0 V to the set value (1.8 V in this example). This charge arrives in the form of inrush current. Calculate inrush current using [方程式 1](#).

$$\text{Inrush Current} = C_L \times dV_{\text{OUT}}/dt \quad (1)$$

Where:

- C_L is the output capacitance.
- dV_{OUT} is the change in V_{OUT} during the ramp up of the output voltage when device is enabled. Because rise time is 10% of V_{OUT} to 90% of V_{OUT} , this is 80% of the V_{IN} value.
- dt is the rise time in V_{OUT} during the ramp up of the output voltage when the device is enabled.

The TPS22998 offers an adjustable rise time for V_{OUT} , allowing the user to control the inrush current during turn on. Calculate the appropriate rise time using the design requirements and the inrush current equation as shown below.

$$1\text{A} = 470 \mu\text{F} \times (1.8 \text{V} \times 80\%) / dt \quad (2)$$

$$dt = 677 \mu\text{s} \quad (3)$$

To ensure an inrush current of less than 1 A, a C_T setting that yields a rise time of more than 677 μs must be chosen. By pulling the CT pin high, a rise time of 900 μs is selected, limiting the inrush current to below 1 A.

8.2.3 Application Performance Plots

The below scope shot shows the TPS22998 turning on into a 470- μF load with the CT pin tied to V_{BIAS} .



图 8-2. TPS22998 Turn-On into 470 μF ($C_T = V_{\text{BIAS}}$)

9 Power Supply Recommendations

The TPS22998 device is designed to operate with a V_{IN} range of 0.2 V to 5.5 V. Regulate the V_{IN} power supply well and place as close to the device terminal as possible. The power supply must be able to withstand all transient load current steps. In most situations, using an input capacitance (C_{IN}) of 1 μ F is sufficient to prevent the supply voltage from dipping when the switch is turned on. In cases where the power supply is slow to respond to a large transient current or large load current step, additional bulk capacitance can be required on the input.

10 Layout

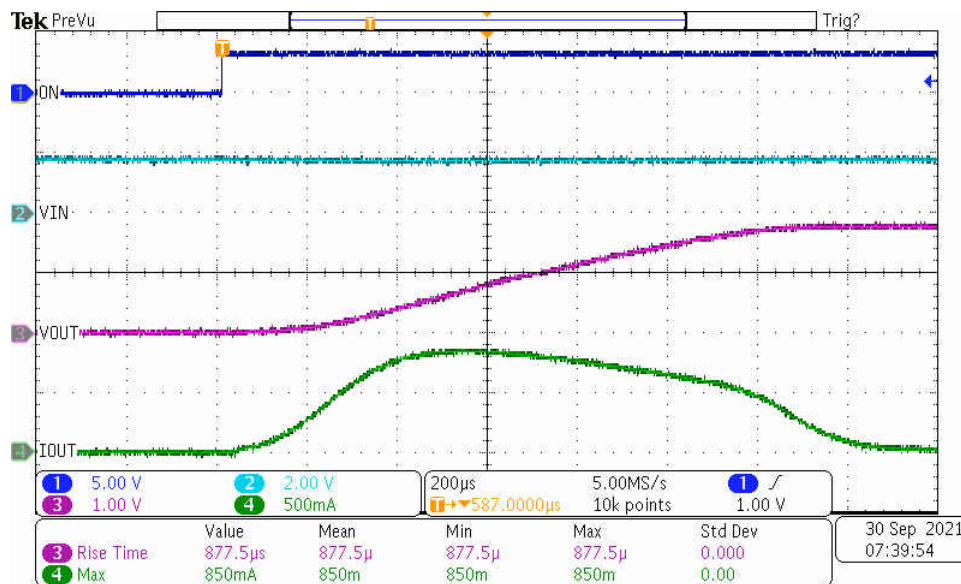
10.1 Layout Guidelines

For best performance, all traces must be as short as possible. To be most effective, place the input and output capacitors close to the device terminal as possible to minimize the effects that parasitic trace inductances can have on normal operation. Using wide traces for V_{IN} , V_{OUT} , and GND helps minimize the parasitic electrical effects.

10.2 Layout Example



图 10-1. TPS22998 Layout Example

11 Device and Documentation Support

TI offers an extensive line of development tools. Tools and software to evaluate the performance of the device, generate code, and develop solutions are listed below.

11.1 接收文档更新通知

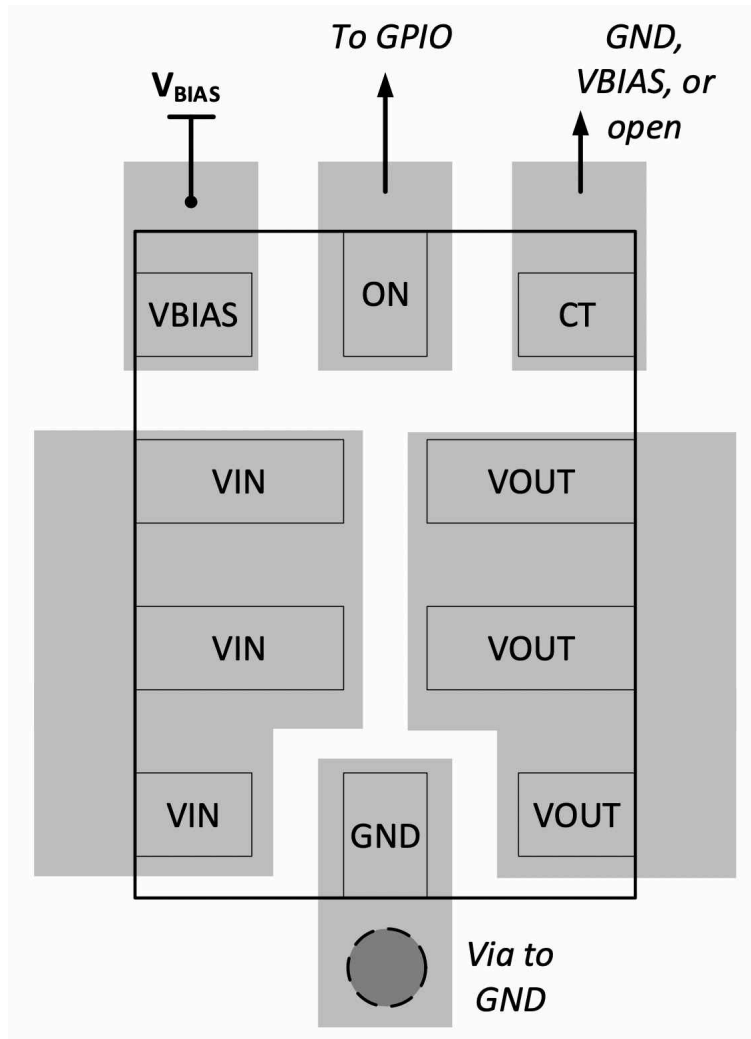
要接收文档更新通知，请导航至 ti.com 上的器件产品文件夹。点击 [订阅更新](#) 进行注册，即可每周接收产品信息更改摘要。有关更改的详细信息，请查看任何已修订文档中包含的修订历史记录。

11.2 支持资源

TI E2E™ [支持论坛](#) 是工程师的重要参考资料，可直接从专家获得快速、经过验证的解答和设计帮助。搜索现有解答或提出自己的问题可获得所需的快速设计帮助。

链接的内容由各个贡献者“按原样”提供。这些内容并不构成 TI 技术规范，并且不一定反映 TI 的观点；请参阅 TI 的 [《使用条款》](#)。

11.3 Trademarks

TI E2E™ is a trademark of Texas Instruments.

所有商标均为其各自所有者的财产。

11.4 Electrostatic Discharge Caution



This integrated circuit can be damaged by ESD. Texas Instruments recommends that all integrated circuits be handled with appropriate precautions. Failure to observe proper handling and installation procedures can cause damage.

ESD damage can range from subtle performance degradation to complete device failure. Precision integrated circuits may be more susceptible to damage because very small parametric changes could cause the device not to meet its published specifications.

11.5 术语表

[TI 术语表](#) 本术语表列出并解释了术语、首字母缩略词和定义。

12 Mechanical, Packaging, and Orderable Information

The following pages include mechanical, packaging, and orderable information. This information is the most current data available for the designated devices. This data is subject to change without notice and revision of this document. For browser-based versions of this data sheet, refer to the left-hand navigation.

PACKAGING INFORMATION

Orderable Device	Status (1)	Package Type	Package Drawing	Pins	Package Qty	Eco Plan (2)	Lead finish/ Ball material (6)	MSL Peak Temp (3)	Op Temp (°C)	Device Marking (4/5)	Samples
PTPS22998RYZR	ACTIVE	WQFN-HR	RYZ	10	3000	TBD	Call TI	Call TI	-40 to 105		Samples
TPS22998RYZR	ACTIVE	WQFN-HR	RYZ	10	3000	RoHS & Green	NIPDAU	Level-2-260C-1 YEAR	-40 to 105	1LF	Samples

(1) The marketing status values are defined as follows:

ACTIVE: Product device recommended for new designs.

LIFEBUY: TI has announced that the device will be discontinued, and a lifetime-buy period is in effect.

NRND: Not recommended for new designs. Device is in production to support existing customers, but TI does not recommend using this part in a new design.

PREVIEW: Device has been announced but is not in production. Samples may or may not be available.

OBSOLETE: TI has discontinued the production of the device.

(2) **RoHS:** TI defines "RoHS" to mean semiconductor products that are compliant with the current EU RoHS requirements for all 10 RoHS substances, including the requirement that RoHS substance do not exceed 0.1% by weight in homogeneous materials. Where designed to be soldered at high temperatures, "RoHS" products are suitable for use in specified lead-free processes. TI may reference these types of products as "Pb-Free".

RoHS Exempt: TI defines "RoHS Exempt" to mean products that contain lead but are compliant with EU RoHS pursuant to a specific EU RoHS exemption.

Green: TI defines "Green" to mean the content of Chlorine (Cl) and Bromine (Br) based flame retardants meet JS709B low halogen requirements of <=1000ppm threshold. Antimony trioxide based flame retardants must also meet the <=1000ppm threshold requirement.

(3) MSL, Peak Temp. - The Moisture Sensitivity Level rating according to the JEDEC industry standard classifications, and peak solder temperature.

(4) There may be additional marking, which relates to the logo, the lot trace code information, or the environmental category on the device.

(5) Multiple Device Markings will be inside parentheses. Only one Device Marking contained in parentheses and separated by a "~" will appear on a device. If a line is indented then it is a continuation of the previous line and the two combined represent the entire Device Marking for that device.

(6) Lead finish/Ball material - Orderable Devices may have multiple material finish options. Finish options are separated by a vertical ruled line. Lead finish/Ball material values may wrap to two lines if the finish value exceeds the maximum column width.

Important Information and Disclaimer:The information provided on this page represents TI's knowledge and belief as of the date that it is provided. TI bases its knowledge and belief on information provided by third parties, and makes no representation or warranty as to the accuracy of such information. Efforts are underway to better integrate information from third parties. TI has taken and continues to take reasonable steps to provide representative and accurate information but may not have conducted destructive testing or chemical analysis on incoming materials and chemicals. TI and TI suppliers consider certain information to be proprietary, and thus CAS numbers and other limited information may not be available for release.

In no event shall TI's liability arising out of such information exceed the total purchase price of the TI part(s) at issue in this document sold by TI to Customer on an annual basis.

RYZ0010A

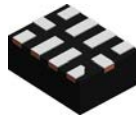

PACKAGE OUTLINE
WQFN-HR - 0.8 mm max height

PLASTIC QUAD FLATPACK - NO LEAD

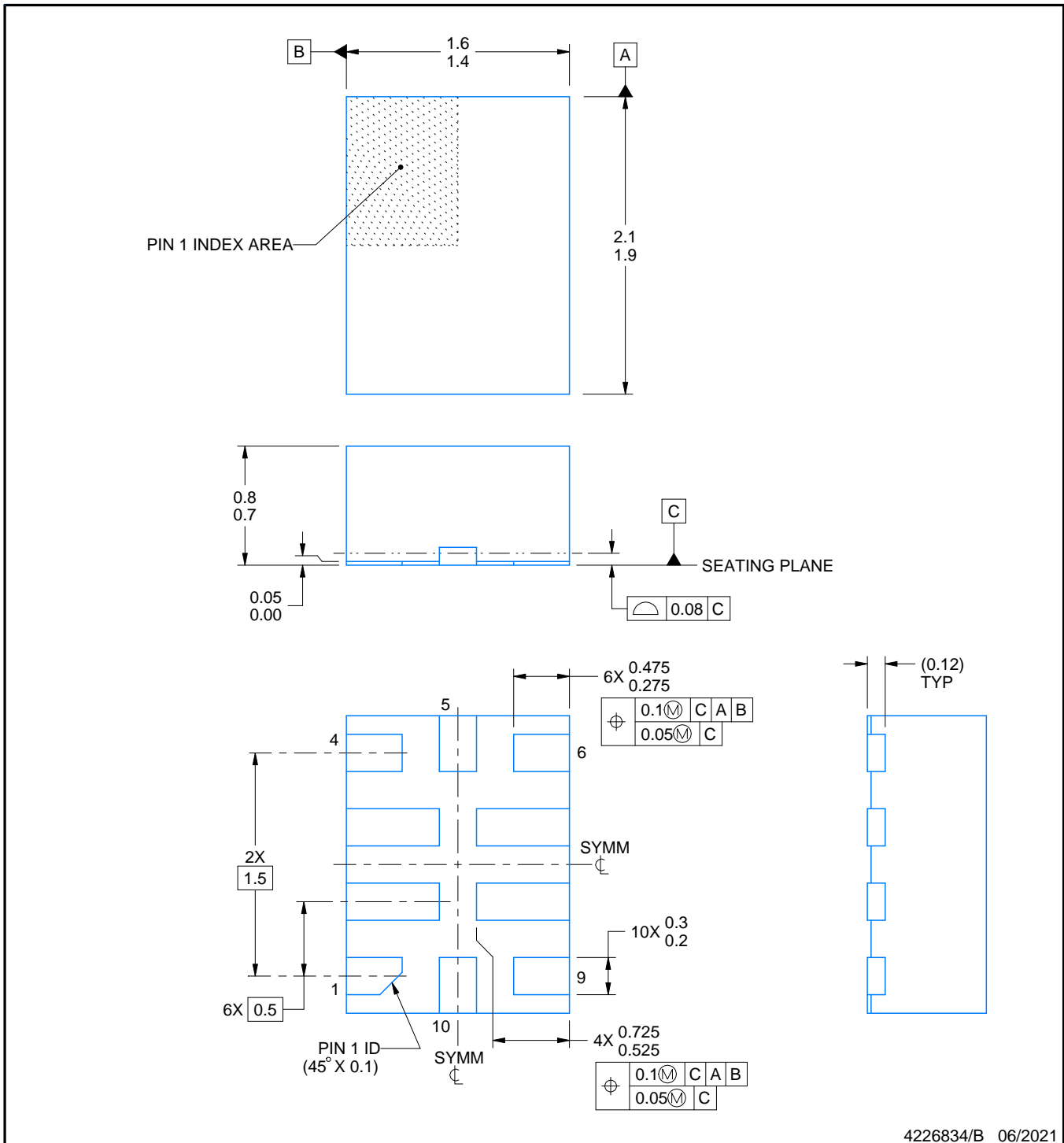

4226834/B 06/2021

NOTES:

1. All linear dimensions are in millimeters. Any dimensions in parenthesis are for reference only. Dimensioning and tolerancing per ASME Y14.5M.
2. This drawing is subject to change without notice.

EXAMPLE BOARD LAYOUT

RYZ0010A

WQFN-HR - 0.8 mm max height

PLASTIC QUAD FLATPACK - NO LEAD

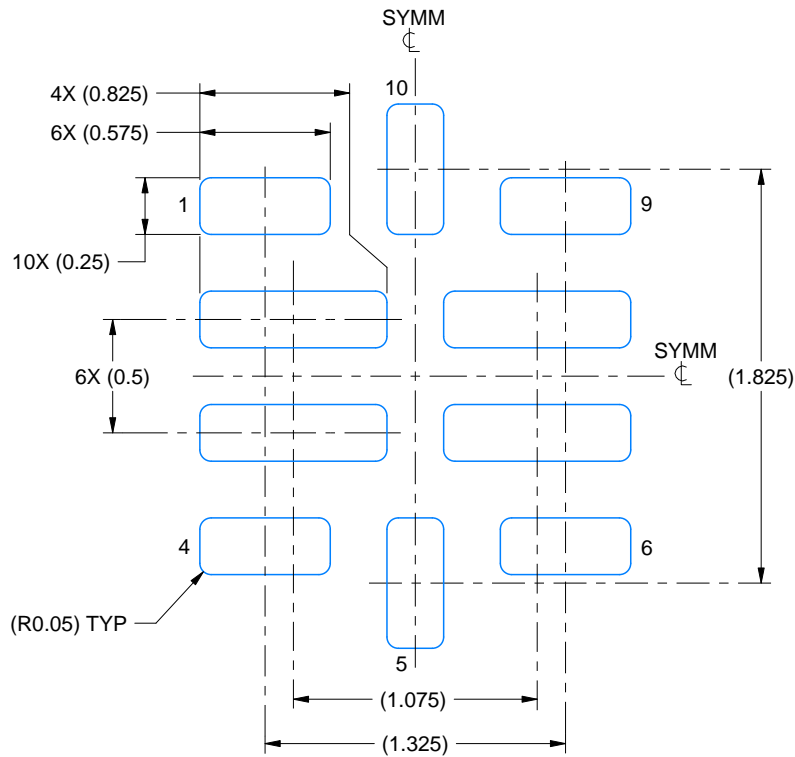

LAND PATTERN EXAMPLE
EXPOSED METAL SHOWN
SCALE:30X

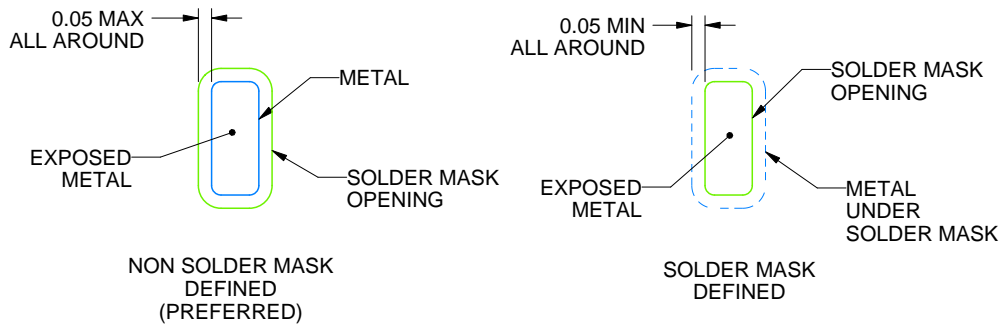

SOLDER MASK DETAILS
NOT TO SCALE

4226834/B 06/2021

NOTES: (continued)

3. For more information, see Texas Instruments literature number SLUA271 (www.ti.com/lit/slua271).

EXAMPLE STENCIL DESIGN

RYZ0010A

WQFN-HR - 0.8 mm max height

PLASTIC QUAD FLATPACK - NO LEAD

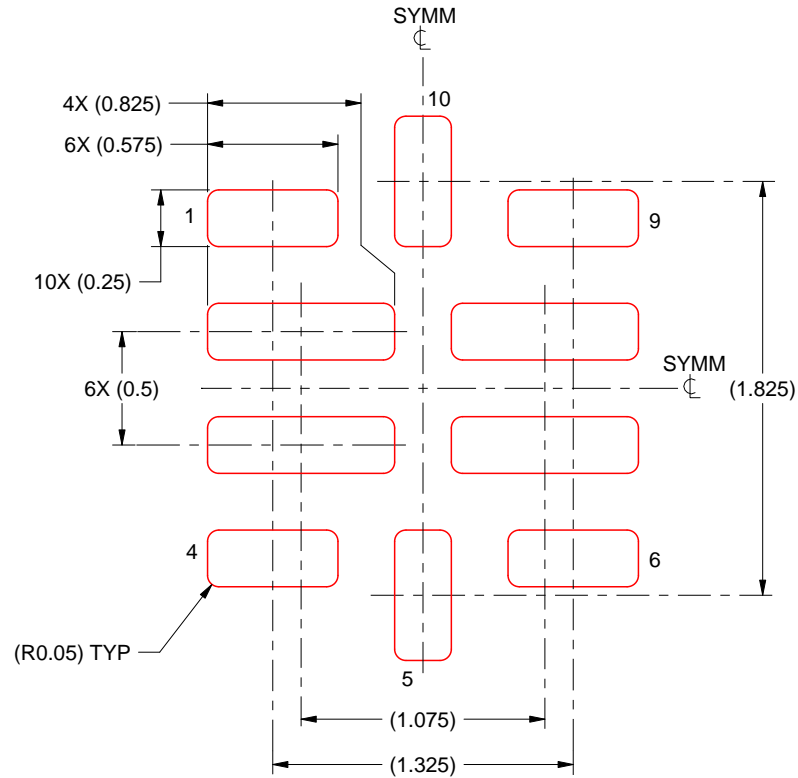

SOLDER PASTE EXAMPLE
BASED ON 0.1 mm THICKNESS
SCALE: 30X

4226834/B 06/2021

NOTES: (continued)

5. Laser cutting apertures with trapezoidal walls and rounded corners may offer better paste release. IPC-7525 may have alternate design recommendations.

重要声明和免责声明

TI“按原样”提供技术和可靠性数据（包括数据表）、设计资源（包括参考设计）、应用或其他设计建议、网络工具、安全信息和其他资源，不保证没有瑕疵且不做任何明示或暗示的担保，包括但不限于对适销性、某特定用途方面的适用性或不侵犯任何第三方知识产权的暗示担保。

这些资源可供使用 TI 产品进行设计的熟练开发人员使用。您将自行承担以下全部责任：(1) 针对您的应用选择合适的 TI 产品，(2) 设计、验证并测试您的应用，(3) 确保您的应用满足相应标准以及任何其他功能安全、信息安全、监管或其他要求。

这些资源如有变更，恕不另行通知。TI 授权您仅可将这些资源用于研发本资源所述的 TI 产品的应用。严禁对这些资源进行其他复制或展示。您无权使用任何其他 TI 知识产权或任何第三方知识产权。您应全额赔偿因在这些资源的使用中对 TI 及其代表造成的任何索赔、损害、成本、损失和债务，TI 对此概不负责。

TI 提供的产品受 [TI 的销售条款](#) 或 [ti.com](#) 上其他适用条款/TI 产品随附的其他适用条款的约束。TI 提供这些资源并不会扩展或以其他方式更改 TI 针对 TI 产品发布的适用的担保或担保免责声明。

TI 反对并拒绝您可能提出的任何其他或不同的条款。

邮寄地址：Texas Instruments, Post Office Box 655303, Dallas, Texas 75265

Copyright © 2022，德州仪器 (TI) 公司