

N-Channel Enhancement Mode MOSFET

TDM3458

DESCRIPTION

The TDM3458 uses advanced trench technology to provide excellent RDS(ON) and low gate charge. This device is suitable for use as a load switch or in PWM applications.

GENERAL FEATURES

- RDS(ON) < 8.7mΩ @ VGS=4.5V
RDS(ON) < 5.5mΩ @ VGS=10V
- High Power and current handling capability
- Lead free product is available
- ESD protection
- Surface Mount Package

Application

- PWM applications
- Load switch
- Power management

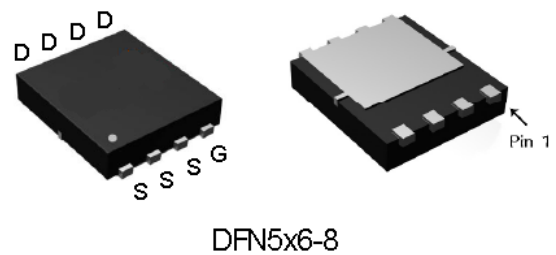
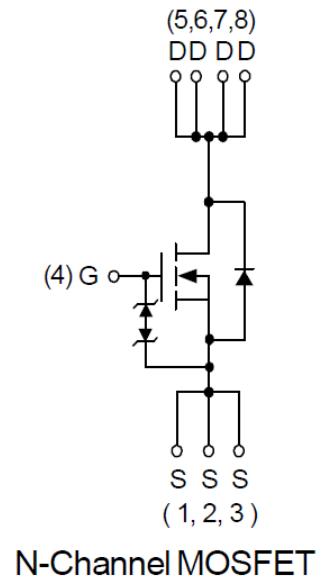

ABSOLUTE MAXIMUM RATINGS(T_A=25°C unless otherwise noted)

Parameter	Symbol	Limit	Unit
Drain-Source Voltage	V _{DS}	30	V
Gate-Source Voltage	V _{GS}	±20	V
Drain Current @ Continuous	I _D (T _C =25°C)	60	A
	I _D (T _C =100°C)	38	A
Drain Current @ Current-Pulsed (Note 1)	I _{DM} (T _C =25°C)	120	A
Maximum Power Dissipation	P _D (T _C =25°C)	29.8	W
	P _D (T _C =100°C)	11.9	W
Drain Current @ Continuous (Note 2)	I _D (T _A =25°C)	17.4	A
	I _D (T _A =70°C)	13.9	A
Maximum Power Dissipation (Note 2)	P _D (T _A =25°C)	2.5	W
	P _D (T _A =70°C)	1.6	W
Maximum Operating Junction Temperature	T _J	150	°C
Storage Temperature Range	T _{STG}	-55 To 150	°C

N-Channel Enhancement Mode MOSFET
TDM3458
THERMAL CHARACTERISTICS

Thermal Resistance, Junction-to-Ambient (Note 2)	R θ JA(t \leq 10s)	20	°C/W
	R θ JA(Steady State)	50	°C/W
Thermal Resistance, Junction-to-Case	R θ JC(Steady State)	4.2	°C/W

ELECTRICAL CHARACTERISTICS (T_A=25°C unless otherwise noted)

Parameter	Symbol	Condition	Min	Typ	Max	Unit
OFF CHARACTERISTICS						
Drain-Source Breakdown Voltage	BV _{DSS}	V _{GS} =0V I _D =250μA	30	-	-	V
Zero Gate Voltage Drain Current	I _{DSS}	V _{DS} =24V, V _{GS} =0V	-	-	1	μA
Gate-Body Leakage Current	I _{GSS}	V _{GS} =±20V, V _{DS} =0V	-	-	±100	nA
ON CHARACTERISTICS (Note 3)						
Gate Threshold Voltage	V _{GS(th)}	V _{DS} =V _{GS} , I _D =250μA	1.4	1.7	2.5	V
Drain-Source On-State Resistance	R _{DS(ON)}	V _{GS} =4.5V, I _D =10A	-	6.7	8.7	mΩ
		V _{GS} =10V, I _D =15A	-	4.5	5.5	mΩ
		T _J =125°C	-	6.75	-	mΩ
DYNAMIC CHARACTERISTICS (Note 4)						
Gate Resistance	R _G	V _{DS} =0V, V _{GS} =0V, F=1.0MHz	-	1.6	2.5	Ω
Input Capacitance	C _{iss}	V _{DS} =15V, V _{GS} =0V, F=1.0MHz	-	780	1010	PF
Output Capacitance	C _{oss}		-	510	-	PF
Reverse Transfer Capacitance	C _{rss}		-	39	-	PF
SWITCHING CHARACTERISTICS (Note 4)						
Turn-on Delay Time	t _{d(on)}	V _{DS} =15V, R _L =15 Ω, V _{GEN} =10V, R _G =1 Ω I _D =1A	-	11	-	nS
Turn-on Rise Time	t _r		-	8	-	nS
Turn-Off Delay Time	t _{d(off)}		-	19.6	-	nS
Turn-Off Fall Time	t _f		-	17	-	nS
Total Gate Charge	Q _g	V _{DS} =15V, I _D =15A, V _{GS} =4.5V	-	5.8	-	nC
Gate-Source Charge	Q _{gs}		-	3	-	nC
Gate-Drain Charge	Q _{gd}		-	1.5	-	nC
Body Diode Reverse Recovery Time	T _{rr}	I _F =5A, di/dt=100A/μs	-	25	-	nS
Body Diode Reverse Recovery Charge	Q _{rr}		-	11.8	-	nC
DRAIN-SOURCE DIODE CHARACTERISTICS						
Diode Forward Voltage (Note 3)	V _{SD}	V _{GS} =0V, I _S =20A	-	0.81	1.1	V

NOTES:

1. Pulse width limited by max. junction temperature.
2. R θ JA steady state t=100s.
3. Pulse Test: Pulse Width \leq 300μs, Duty Cycle \leq 2%.
4. Guaranteed by design, not subject to production testing

Typical Operating Characteristics

Power Dissipation

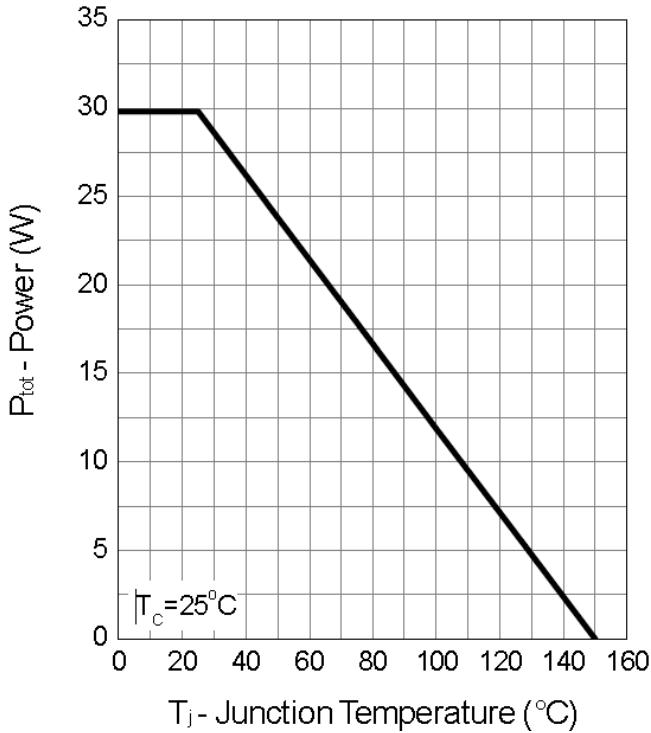

Drain Current

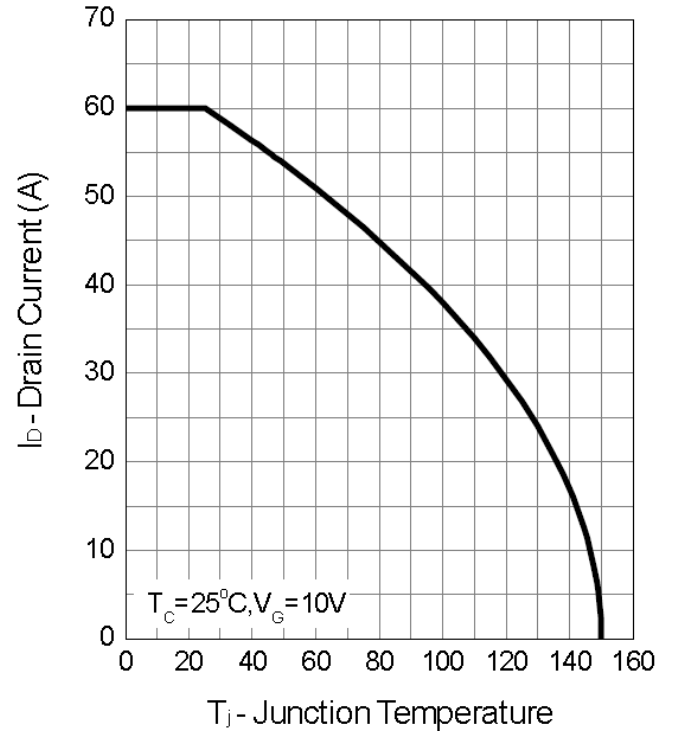

Safe Operation Area

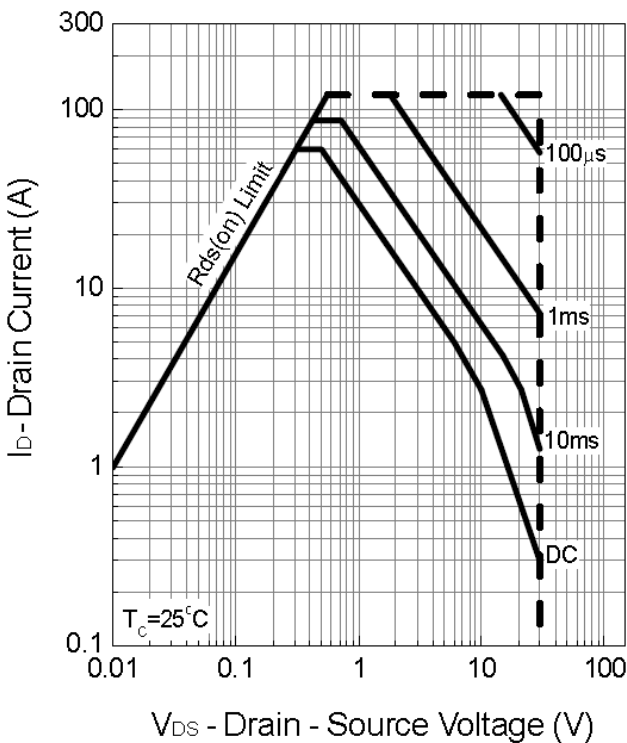

Thermal Transient Impedance

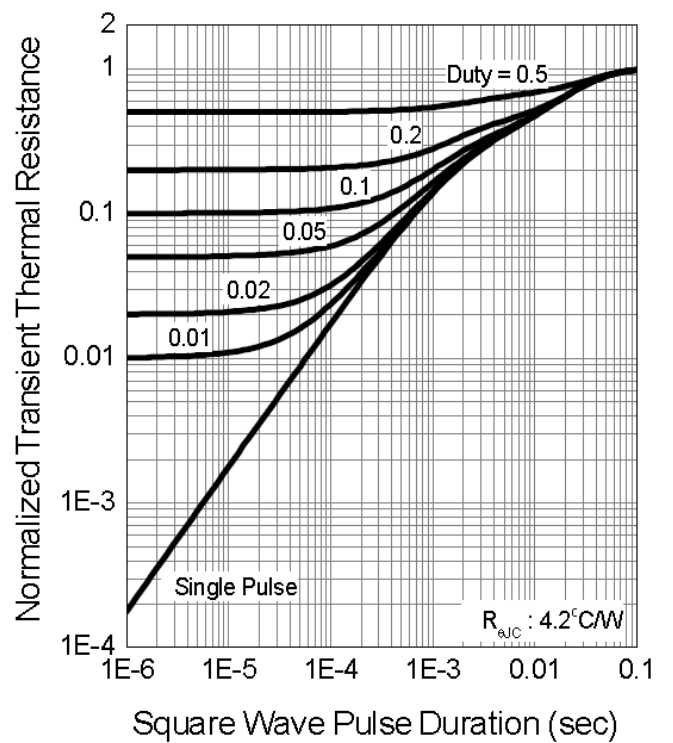

Typical Operating Characteristics(Cont.)

Safe Operation Area

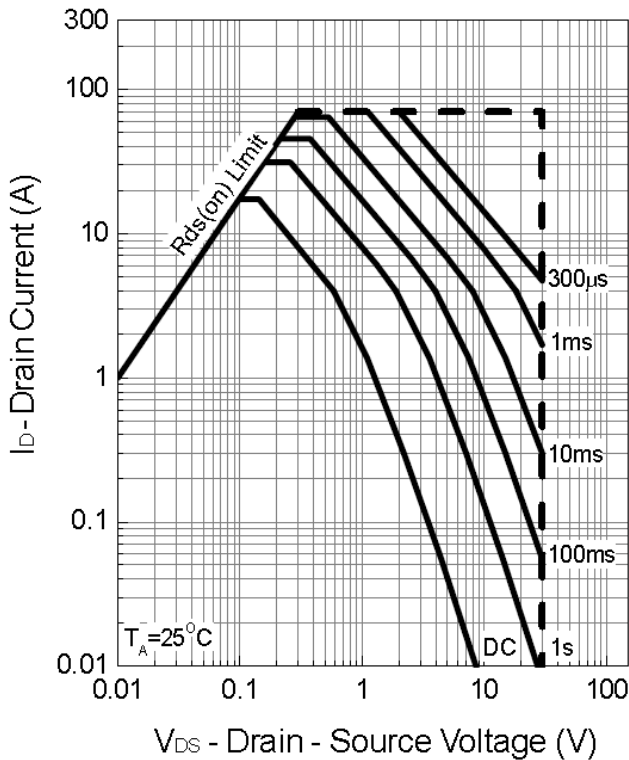

Thermal Transient Impedance

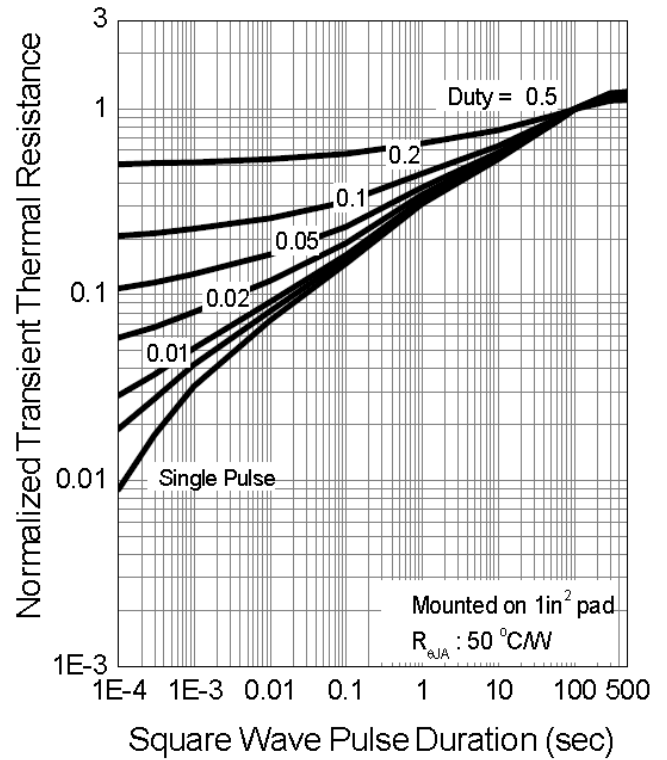

Output Characteristics

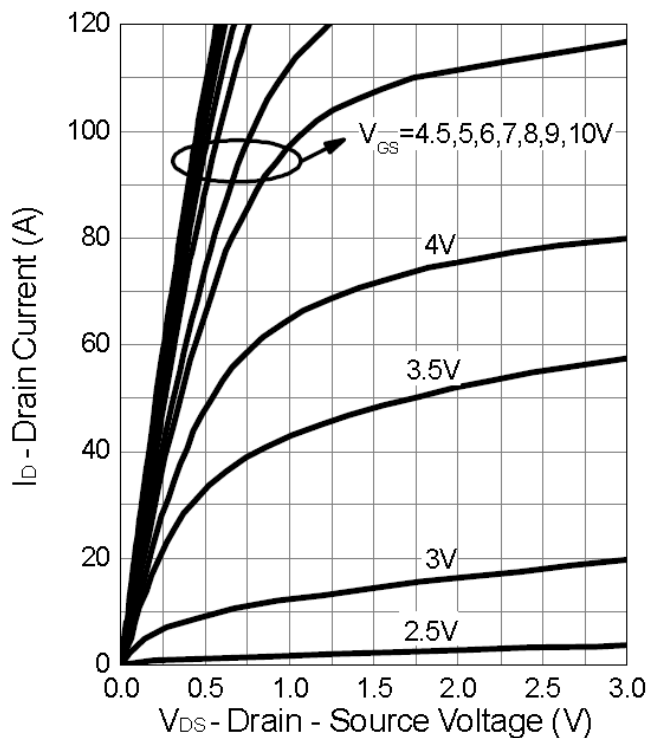

Drain-Source On Resistance

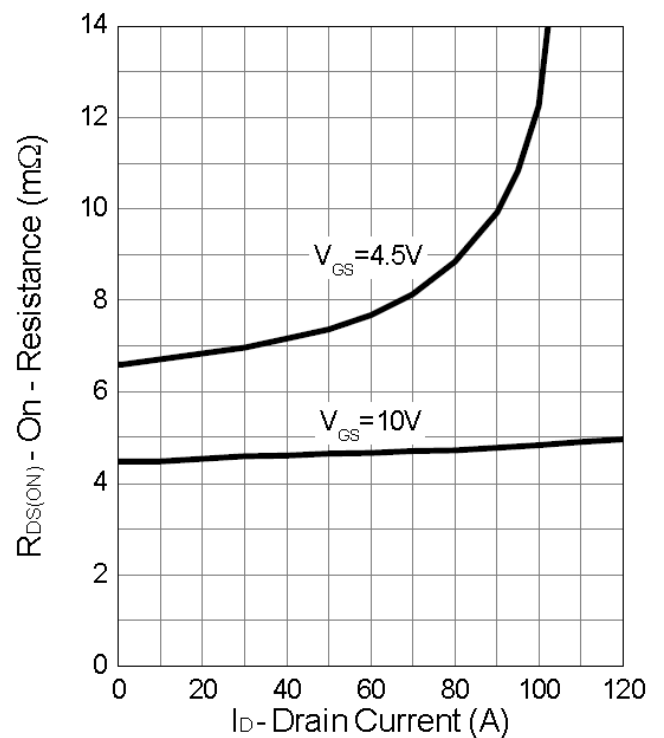

Typical Operating Characteristics (Cont.)

Gate-Source On Resistance

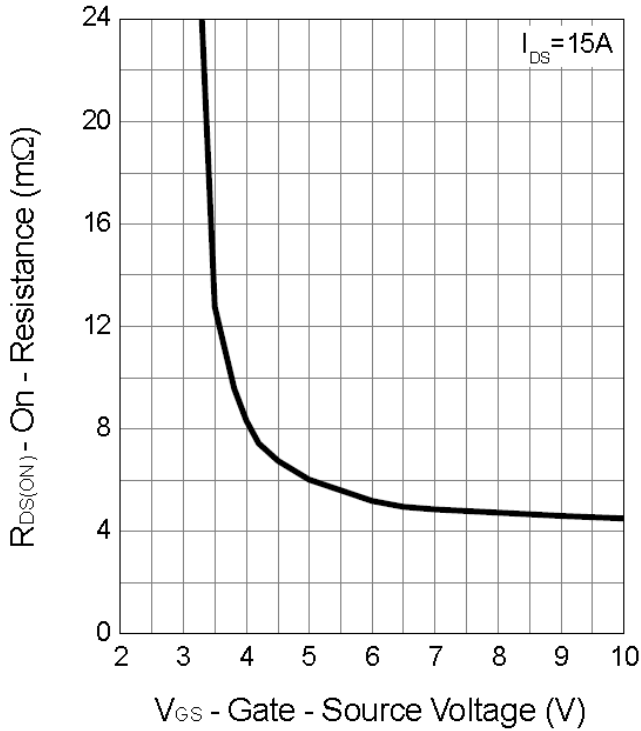

Gate Threshold Voltage

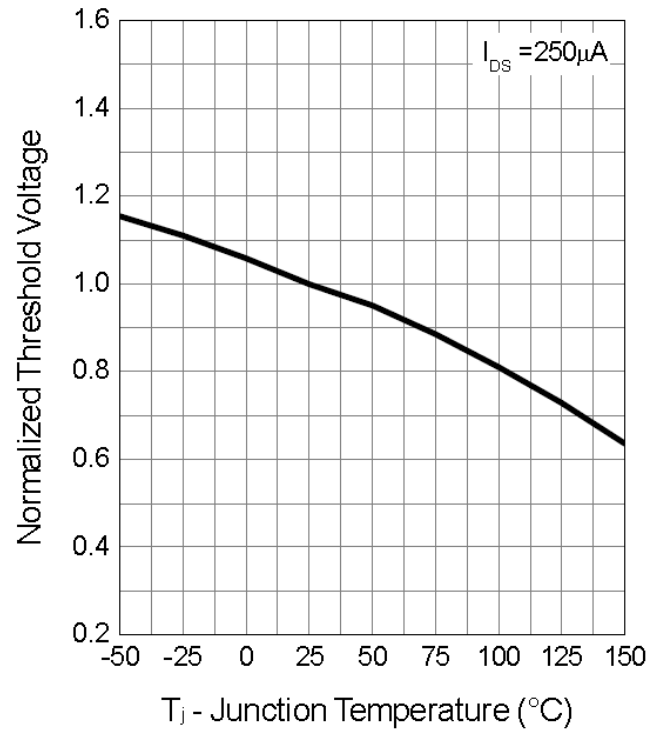

Drain-Source On Resistance

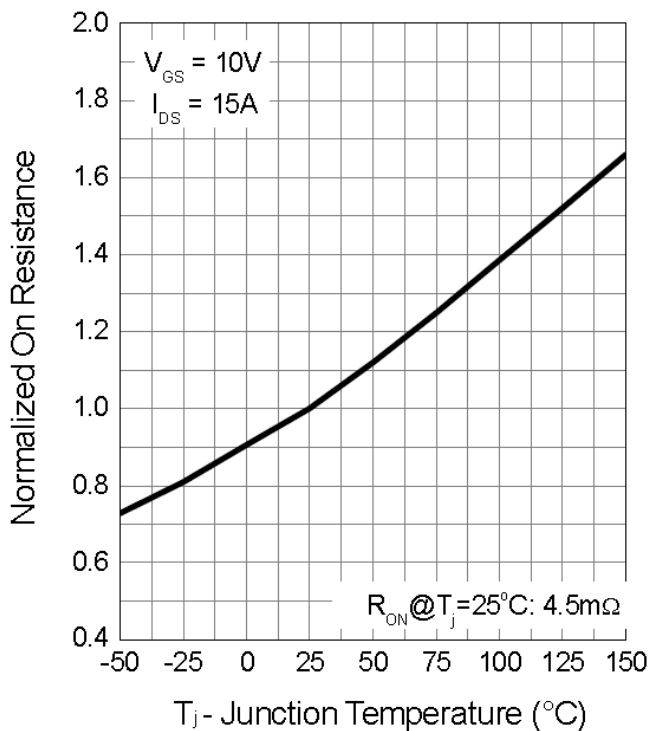

Source-Drain Diode Forward

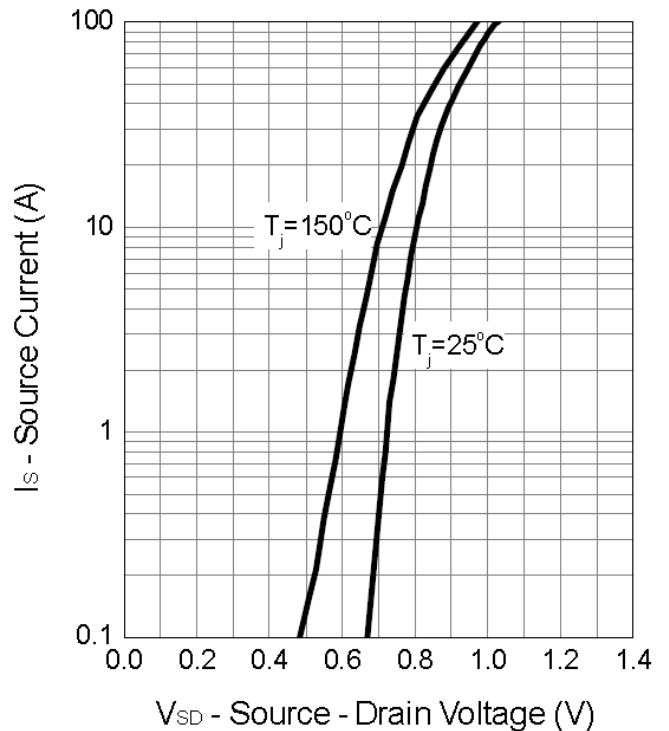

Typical Operating Characteristics (Cont.)

Capacitance

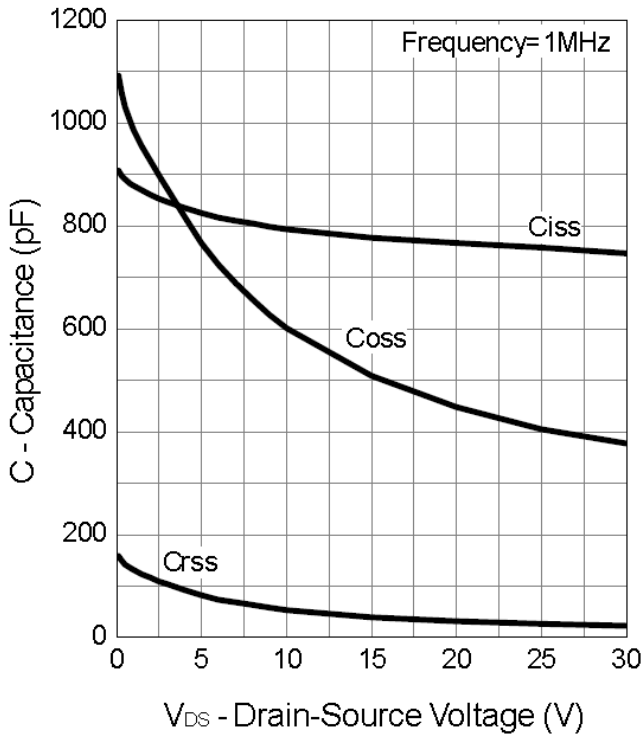

Gate Charge

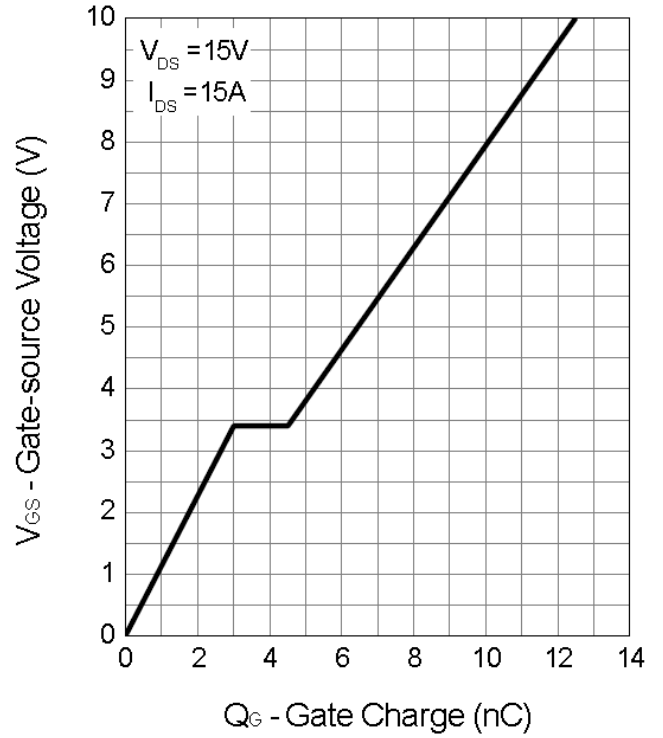

Transfer Characteristics

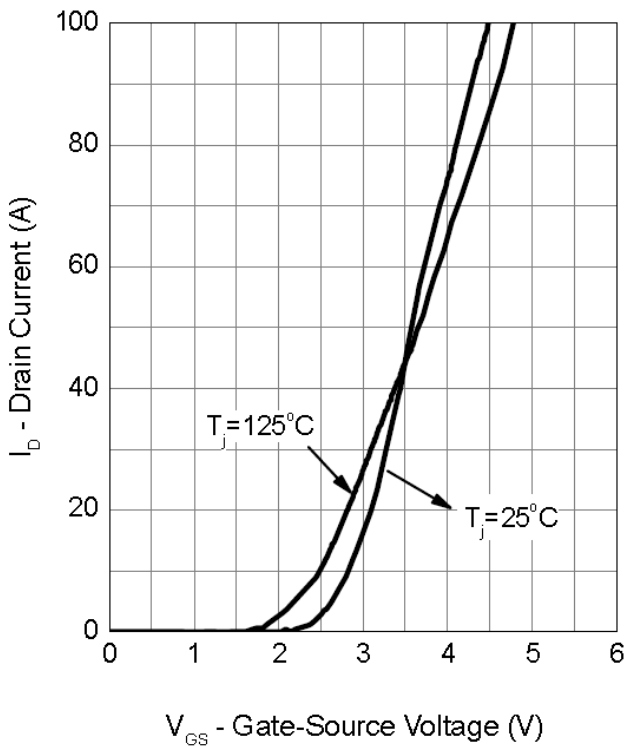

Package Information

DFN5*6-8 Package

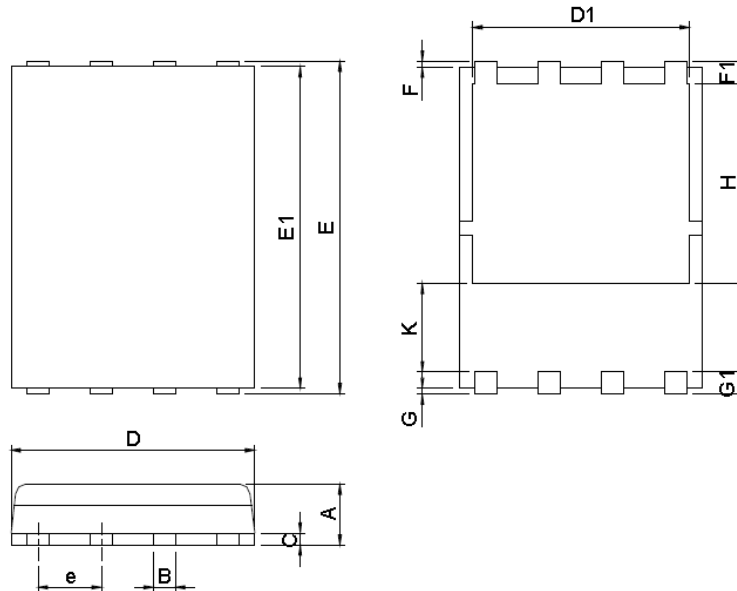

DIMENSIONS	DFN5x6-8			
	MILLIMETERS		INCHES	
	MIN.	MAX.	MIN.	MAX.
A	0.90	1.20	0.035	0.047
B	0.3	0.51	0.012	0.020
C	0.19	0.25	0.007	0.010
D	4.80	5.30	0.189	0.209
D1	4.00	4.40	0.157	0.173
E	5.90	6.20	0.232	0.244
E1	5.50	5.80	0.217	0.228
e	1.27 BSC		0.050 BSC	
F	0.05	0.30	0.002	0.012
F1	0.35	0.75	0.014	0.030
G	0.05	0.30	0.002	0.012
G1	0.35	0.75	0.014	0.030
H	3.34	3.9	0.131	0.154
K	0.762	-	0.03	-

RECOMMENDED LAND PATTERN

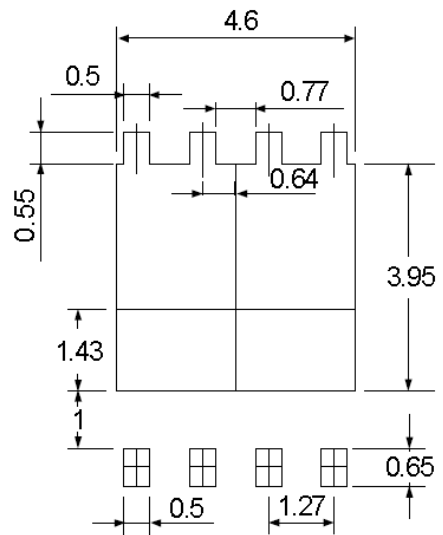

UNIT: mm

Note : 1.Dimension D, D1,D2 and E1 do not include mold flash or protrusions.
Mold flash or protrusions shall not exceed 10 mil.

Design Notes